

Installation Manual

PWS1-500K Series Energy Storage PCS

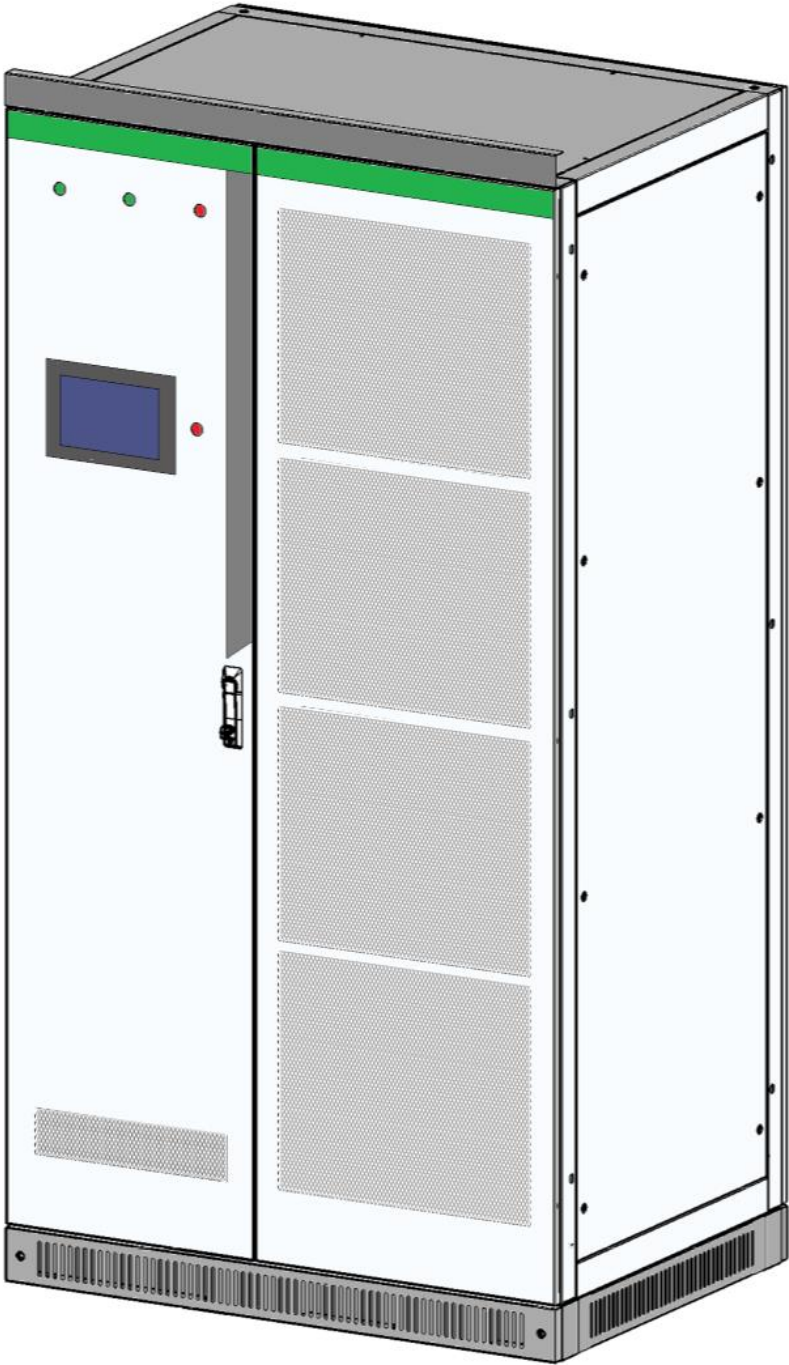

Sinexcel

PWS1-500K Series Bi-directional Energy Storage PCS

Installation Manual

Version: V2.0

Shenzhen Sinexcel Electric Co., Ltd.

All rights reserved. In case of any content change, it shall be without prior notice.

Shenzhen Sinexcel Electric Co., Ltd.

Website: <http://sinexcel.us/> or www.sinexcel.com

Add: Building 6, Area 2, Baiwangxin High-tech Industrial Park, No. 1002, Songbai Road, Nanshan District, Shenzhen

Postcode: 518055

Hotline: +86 0755-8651-1588

Table of Contents

1 Information on this Document.....	3
1.1 Validity.....	3
1.2 Target Group.....	3
2 Safety Precautions.....	4
2.1 Important Safety instructions.....	4
2.2 Additional Information.....	5
3 Installation design.....	6
3.1 Installation process.....	6
4 Storing, lifting and transporting.....	7
4.1 Scope of Delivery.....	7
4.2 Safety during Transport.....	7
4.2 Transporting the PCS.....	7
4.2.1 Transport and storage.....	7
4.2.2 Transporting.....	8
4.3 Unpacking the PCS.....	8
5 Mechanical Installation.....	9
5.1 Safety during Installation.....	9
5.2 Installation requirements.....	10
5.2.1 Environment requirements.....	10
5.2.2 Ground requirements.....	10
5.2.3 Ventilation.....	10
5.2.4 Operation space.....	10
5.2.5 Other requirements.....	12
5.3 Mounting preparation.....	12
5.4 Rack installation.....	13
5.5 Installation in container.....	15
5.5.1 Container internal layout distance.....	15
5.5.2 Fan installed inside the container.....	16
5.5.3 Fan installed outside the container.....	17
5.5.4 Air duct design.....	18
5.5.5 Installation of Fan module.....	19
6 Electrical Installation.....	20
6.1 Electrical Connections.....	20
6.1.1 Input requirement.....	20
6.1.2 Output requirement.....	20
6.1.3 Wiring mode.....	20
6.1.4 System grounding.....	28
6.1.5 DC port wiring.....	28
6.1.6 AC port wiring.....	29
6.1.7 Wiring of terminal strips.....	30
6.2 Communication interface.....	33
6.2.1 Connecting the EMS over RS485 or Ethernet.....	33
6.2.2 Connecting a BMS over CAN.....	34
6.3 Check after installation.....	34
7 Installation checklist.....	36
8 Start-up and Operation.....	37
9 Contact.....	38

1 Information on this Document

1.1 Validity

This document is valid for the following device models with or without STS module:

- PWS1-500K
- PWS1-500KTL
- PWS1-500KTL-NA
- PWS1-500KTL-EX

Model definition

This section introduces product model definition in this user's manual, as shown in Fig. 1-1:

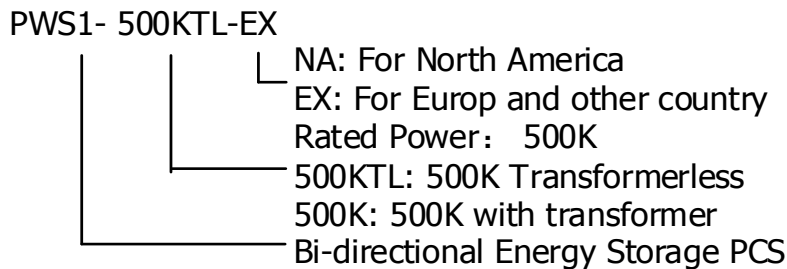

Fig.1-1 Product model definition

For example:

PWS1-500KTL: 500kW Bi-directional storage inverter without isolation transformer.

PWS1-500K: 500kW Bi-directional storage inverter with isolation transformer.

Check the type label for the production version of PCS.

The illustrations in this document have been reduced to be necessary and may differ from the real product.

1.2 Target Group

The tasks described in this document can only be performed by professionals or other qualified persons.

Qualified persons must have the following skills:

- Understand how the product works and how to operate the product
- Understand how the battery works and how to operate the battery
- Training on how to deal with the hazards and risks associated with installing and using electrical equipment installation
- Installation and commissioning of electrical equipment and installations
- Understand all applicable standards and directives
- Understand and follow this manual and all safety information

2 Safety Precautions

2.1 Important Safety instructions

This user's manual is about installation and operation of Sinexcel PWS1-500K series Bi-directional Storage Inverter (PCS).

Before installation, please read this user's manual carefully.

The PCS must be commissioned and maintained by the engineers designated by the manufacturer or the authorized service partner. Otherwise, it might endanger personal safety and result in device fault. Any damage against the device caused thereby shall not be within the warranty scope.

The PCS cannot be used for any circumstance or application related to life support device.

This manual contains important instruction for Models of PWS1 series that shall be followed during installation and maintenance of the PCS.



DANGER

Any contact with copper bar, contactor and terminal inside the device or connected with the loop of utility grid might result in burning or fatal electric shock.

Don't touch any terminal and conductor connected with the loop of utility grid.

Pay attention to any instruction and safety documents about power on-grid.



WARNING

There might be an electric shock risk inside the device!

Any operation related to this device will be conducted by professionals.

Pay attention to the safety precautions listed in safety instruction and installation documents.

Pay attention to the safety precautions listed in operating and installation manual and other documents.



WARNING

Large leakage current

Before connecting input power supply, please ensure that the grounding is reliable.

The device must be grounded complying with the local electric codes.



WARNING

When storage battery is connected to PCS, there may be DC voltage at input port. Please pay attention to it during operation or check the battery system user manual



WARNING

Don't touch electric parts within 15 minutes after power outage!

There is dangerous energy in capacitance storage. Don't touch device terminal, contactor and cooper bar and other electric parts within 15 minutes after disconnecting all device power supplies.



NOTICE

All maintenance and preservation inside the device require using tools and shall be conducted by trained person. The components behind the protective cover plate and dam board which are opened by tools cannot be maintained by users.

Please read this user's manual before operation.

2.2 Additional Information

Links to additional information can be found at <http://sinexcel.us/> or www.sinexcel.com.

3 Installation design

3.1 Installation process

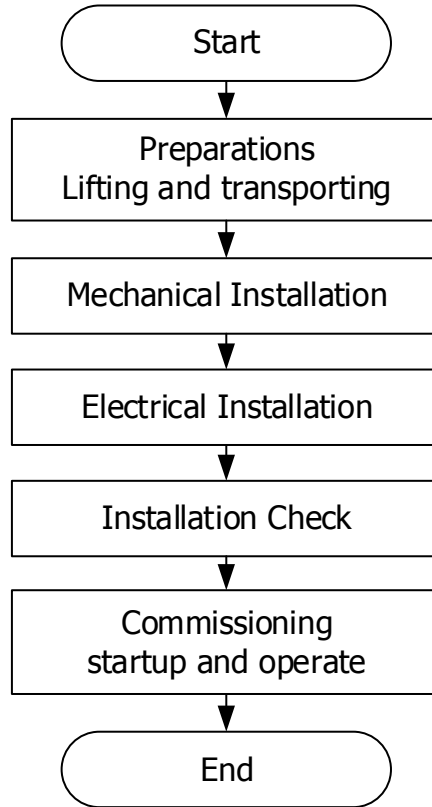

Fig. 3-1 Installation Process

Installation process description

Process	Explanation	Chapter
Preparation Lifting and transporting		4 Storing, lifting and transporting
Mechanical Installation		5 Mechanical Installation
Electrical Installation		6 Electrical Installation
Installation Check		7 Installation checklist
Commissioning startup and operate		8 Start-up and Operation

4 Storing, lifting and transporting

4.1 Scope of Delivery

Refer table below for packing list of rack of storage inverter:

Table 4-1 Scope of Delivery

Item	Quantity	Remark
User's manual	1 copy	Electronic Document
Overall dimension and foundation installation diagram		
Schematic diagram	1 copy	Electronic Document
External terminal diagram		
Certificate of quality	1 copy	

The electronic document can be downloaded from Sinexcel's website or provided by Sinexcel's staff.

4.2 Safety during Transport



WARNING

If the lifted or suspended load falls over, falls or sways, there is a risk of crushing. Vibration or careless or hasty lifting and transport can cause the product to tip over or fall. This can result in death or serious injury.

All national transport standards and regulations must be respected.

Always transport the product as close as possible to the floor.

Avoid fast or uneven movement during transport.

Always maintain a sufficient safety distance from the product during transportation.



NOTICE

Damaged frame structure of the PCS due to uneven support surface

Placing the PCS on an uneven surface can cause bending, which causes the PCS door to no longer close properly.

This can cause moisture and dust to seep into the PCS.

Do not place the PCS on an unstable, uneven surface, even for short periods of time.

The unevenness of the support surface must be less than 0.25%.

Do not use the installed kick plate to transport the PCS.

4.2 Transporting the PCS

4.2.1 Transport and storage

The module of the PCS are installed in the PCS cabinet rack during shipping. During device transport and storage, pay attention to the caution sign on the packing case.

The selection of storing position should ensure that:

- There is no corrosive gas around it.

- There are over-wetting and high-temperature sources.
- It is not a dusty environment.
- It complies with the local firefighting requirements.



NOTICE

During rack transport and storage, stacking is not allowed. The device top cannot be placed with other articles.

The rack should be placed vertically at forward direction. Keep it upright and don't place it horizontally.

4.2.2 Transporting

When removing the PCS unpacked from packing case, a forklift can be used to remove the whole PCS cabinet rack.

Users can lift the device bottom with a forklift . There is no lifting hole on its top.



Fig. 4-1 Moving PCS



WARNING

Before the rack is moved, please ensure that the module is fixed stably.

4.3 Unpacking the PCS

Please take care to protect the PCS inside the package when unpacking.



NOTICE

PCS can't be inverted and the vertical tilt angle should not exceed 30 degree.

5 Mechanical Installation

5.1 Safety during Installation



DANGER

Risk of electric shock caused by live voltage

There is a high voltage in the live components of the product. Touching field components can result in death or seriousness electric shock damage.

Wear appropriate personal protective equipment for all work on the product.

Do not touch any live components.

Observe all warning messages in products and documents.

Obey all safety information from the battery manufacturer.



DANGER

Electric shock hazard caused by DC cable

The DC cable connected to the battery is live. Contact with live cables can cause electrocuted death or serious injury shock.

Before connecting the DC cable, make sure that the DC cable has no voltage.

Wear appropriate personal protective equipment for all work on the product.



WARNING

Danger to life due to electric shock when entering the storage system

Damage to the insulation in the storage system can result in fatal ground currents. May cause a fatal electric shock. Ensure that the insulation resistance of the storage system exceeds the minimum.

Minimum value: The insulation resistance is: 14k Ω .

The PCS must be installed in a closed electrical operating area.



WARNING

Fire due to failure to observe torque specifications at real-time bolt connections

Failure to comply with the specified torque reduces the current carrying capacity of the live bolt connection, thereby reducing the contact resistance increase.

This can cause the components to overheat and catch fire.

Be sure to always tighten the live bolt connection using the exact torque specified in this document.

Use only the right tools when working on the device.

Avoid repeatedly tightening the live bolt connection as this may result in unacceptably high torque.

5.2 Installation requirements

5.2.1 Environment requirements

It is installed indoor. Direct sunshine, rain and ponding should be avoided.

The installation environment is clean. The air should not contain lots of dust.

The installation position should not be shaky.

Environment temperature should be within the temperature range listed in technical specification.

The installation position is convenient for observing touch screen.

5.2.2 Ground requirements

The rack of the storage inverter needs to be installed on the flat ground. The weight-bearing of the ground for installation should be greater than 1,000kg/ m².

5.2.3 Ventilation

The storage inverter is forced air-cooling. Every module has an independent ventilation route. The module heat dissipation mode is air inlet in the front and air outlet in the rear. The cold air is inhaled from the mesh openings of front door of the rack. After heat absorption, the hot air is discharged from the mesh openings of rear door of the rack.

To ensure the quality of air inlet, please carry out installation according to the operation space requirement in chapter below, and a proper space should be reserved for air inlet and outlet. A blower is recommend to be installed in the machine room so as to ensure that the heat emitted from the storage inverter can be discharged outside the room.



NOTICE

At the rear of the rack, heat dissipation should be guaranteed and ventilation equipment needs to be installed so as to ensure that the heat emitted from the storage inverter can be discharged outside the machine room.

5.2.4 Operation space

The installation space of the PCS should have a proper distance from its peripheral walls so as to ensure that the machine door can be opened and closed conveniently and there will be sufficient space for module insertion and extraction, normal heat dissipation and user's operation.

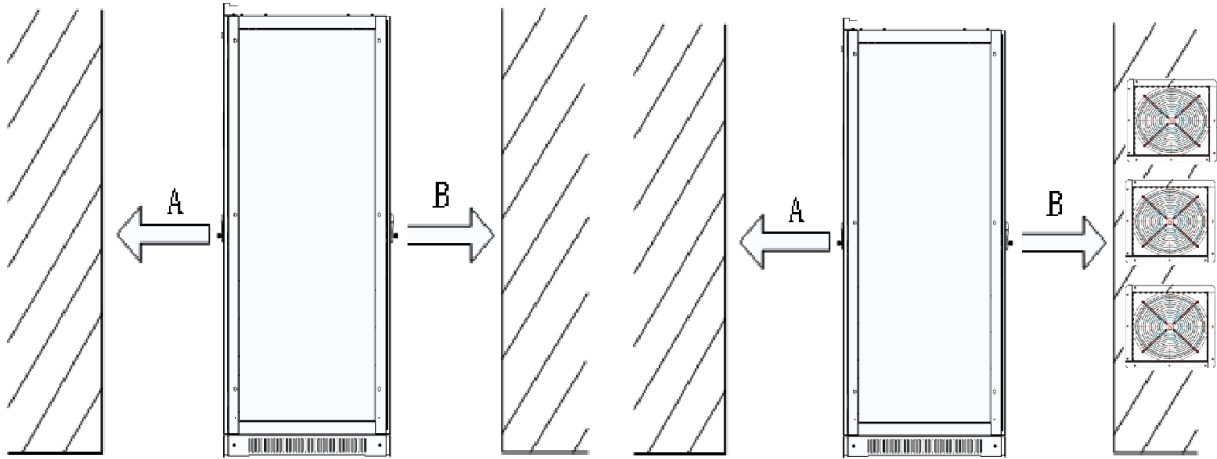

Fig. 5-1 Front and back installation space of storage inverter (Please see Chapter 5.5 Installation in container for the recommend fan location)

Position	Description
A front	$\geq 800\text{mm}$, ensure that the front door of the rack can be fully opened. There is sufficient space for cold air to enter. Users can conveniently insert and extract the module and operate the breaker.
B rear	$\geq 800\text{mm}$, ensure that the rear door of the rack can be fully opened. Please see Chapter 5.5 for the air volume requirements and air duct design. Ventilation and heat dissipation should be ensured. Users can have sufficient space for maintenance.
Or	B rear $\geq 200\text{mm}$ when there are cooling fan near the rear door.

The distance between PCS side steel plate and container wall is no less than 50mm to ensure that the PCS can be installed inside the container.

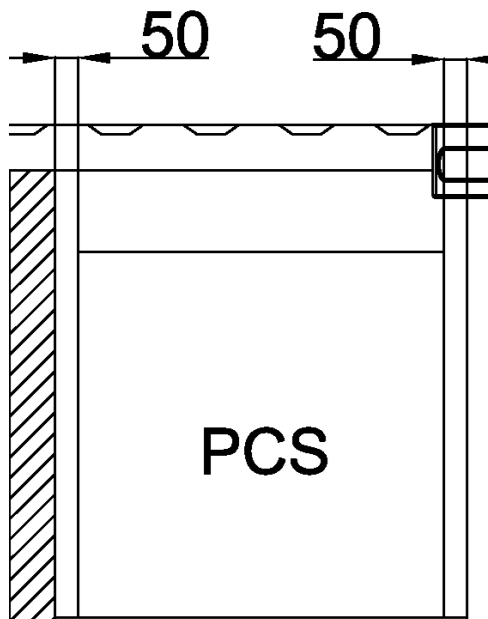

Fig. 5-2 Side installation space of storage inverter

5.2.5 Other requirements

1) Waterproofing

The ingress protection grade of the rack of the Bi-directional Storage Inverter is IP20/NEMA1. It is only installed and used in a dry and clean room. Water leakage in room should be avoided so as to prevent the storage inverter from being damaged.

2) Rat-proofing

After wiring, fireproofing mud should be used to seal inlet and outlet holes so as to meet the rat-proofing requirement. Fireproofing mud is not provided by Sinexcel.

5.3 Mounting preparation

Drilling mounting holes is required in the foundation. The overall dimension of the PCS is shown in figure below.

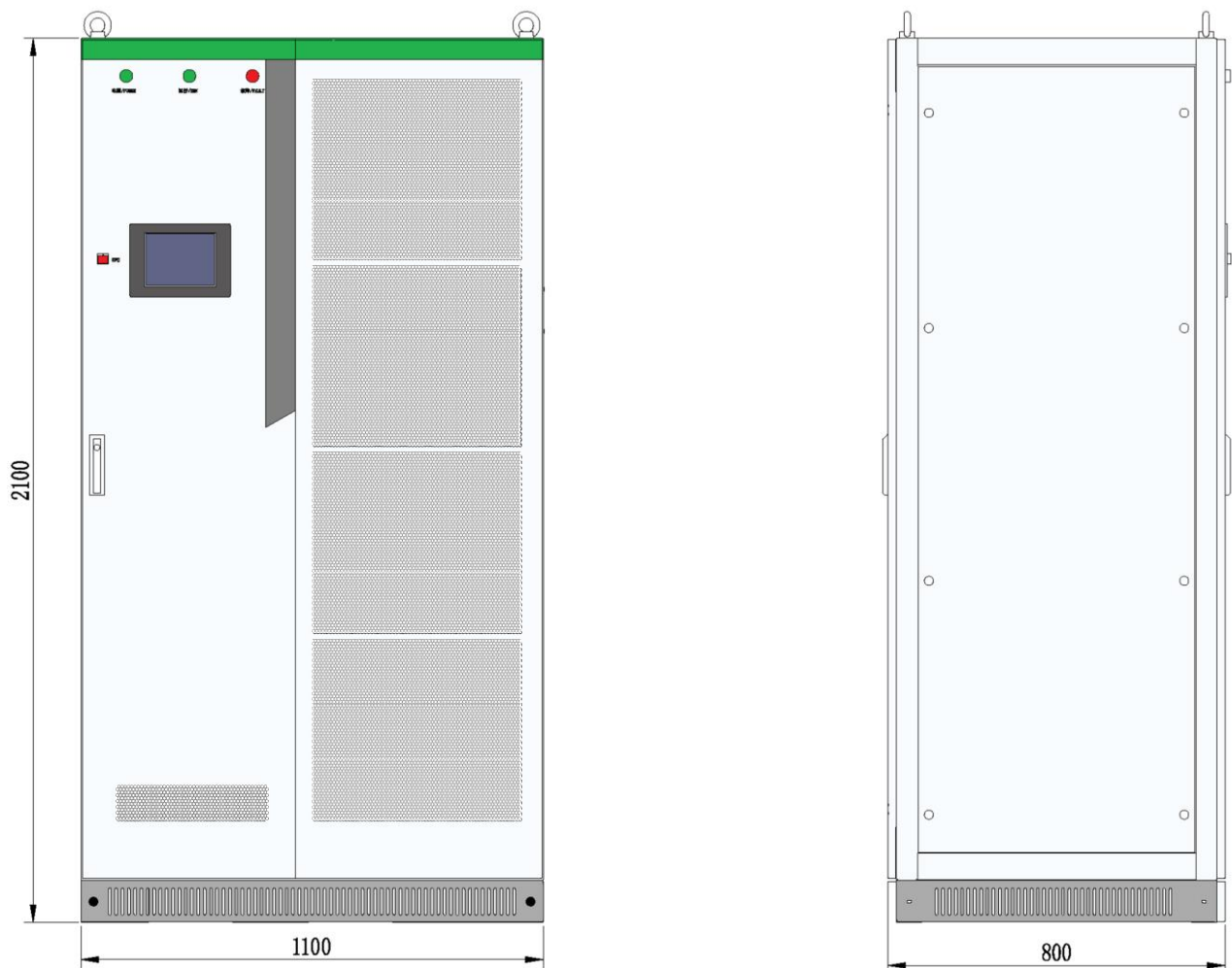

Fig. 5-3 Overall dimensions of PCS

The PWS1-500KTL cabinet, width: 1100mm, height: 2,160mm (without lifting rings); depth: 800mm. The height of the lintel is 60mm and it can be taken down if there is no sufficient height into the room. The PWS1-500KTL series Bi-directional Storage Inverter is without lifting rings and can't be lifted.

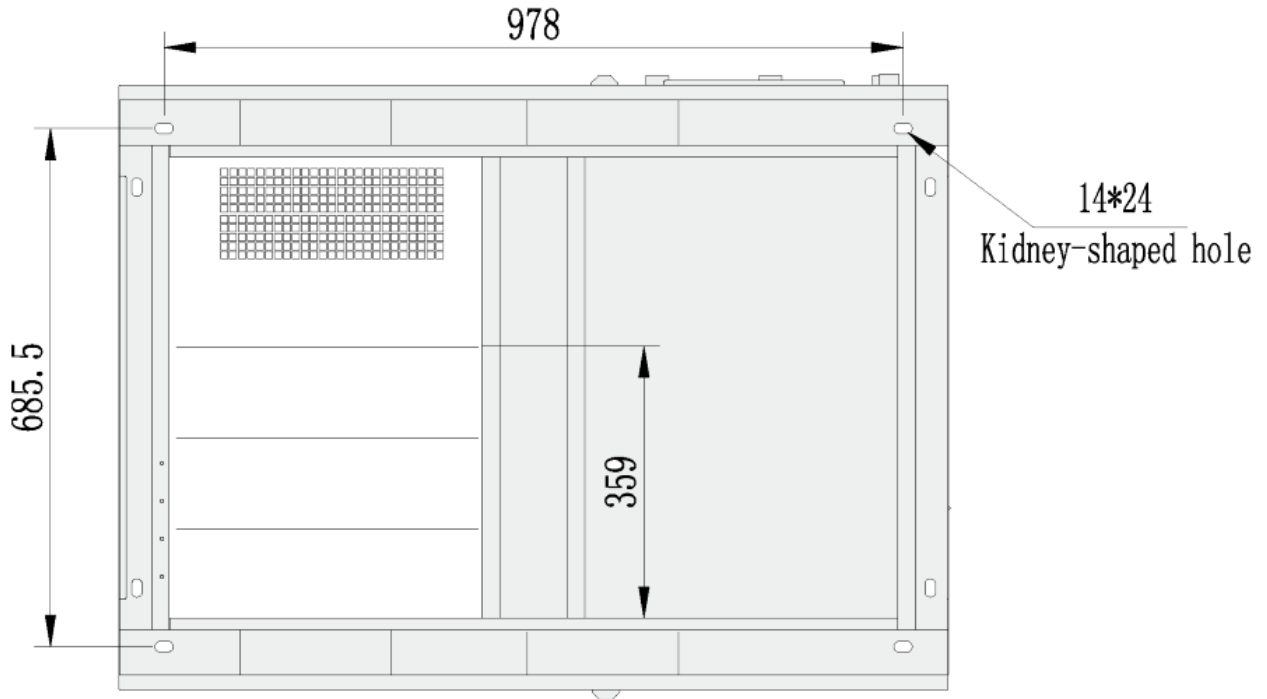

Fig. 5-4 PWS1-500K rack wiring hole in bottom view

There are two hole in each corner, only one hole need to mount bolts, the other hole is used as a spare.

5.4 Rack installation

After the rack is removed to the installation position of BESS (battery energy storage system) with a forklift or a tool. Fine adjust the rack and remove it to the designed position, open the internal door of rack, use M10 or M12 screw to fix the rack.

When the rack needs to be fixed on the steel channel, $\Phi 14$ holes can be made in the steel channel. Fix the rack to the steel channel with screws.

Fig. 5-5 Fix the rack to the channel steel

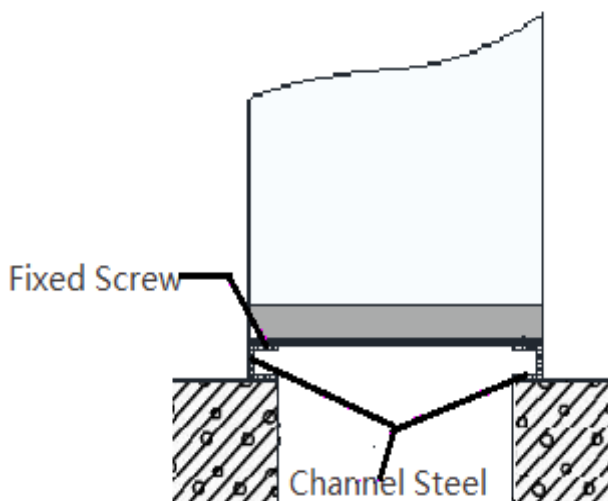
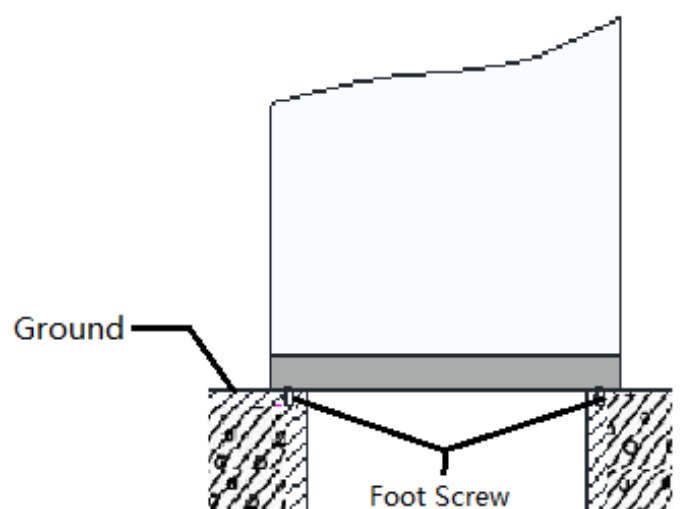

Fig. 5-6 Fix the rack to the concrete floor



When the rack is fixed to the concrete floor, make holes on the floor and fix the rack to the concrete floor with expansion screws.

Module
fastening
bolts

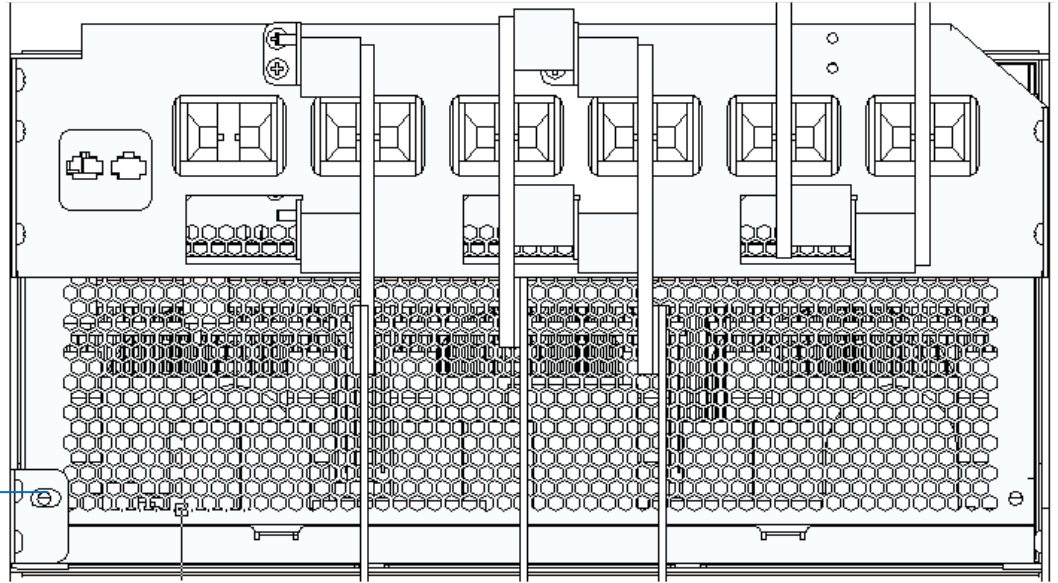

Fig. 5-7 Module fastening bolt position in the back side of each module

After confirming the above items and finished and tested, open the back door of the PCS and remove the module fastening bolts.



NOTICE

Note: Make sure that the module fastening bolts on the back side of power module have been removed before moving the converter into the container.

Can contact the manufacture to confirm.

5.5 Installation in container

5.5.1 Container internal layout distance

Internal layout can be customized design according to customer's requirements. Please contact the manufacture to know the internal layout for specific project.

The distance between PCS side steel plate and container wall is no less than 50mm to ensure that the PCS can be installed inside the container.

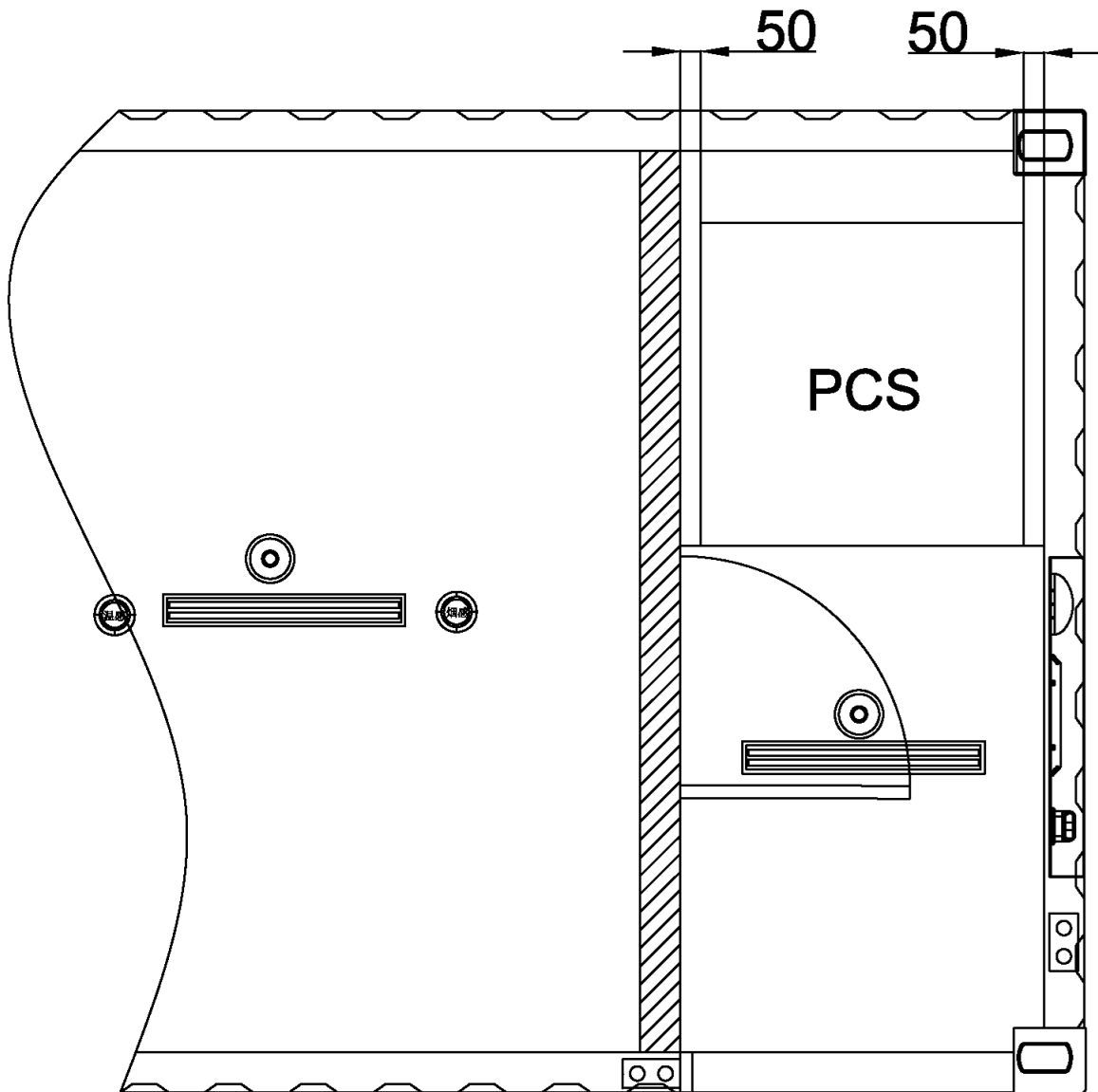

Fig. 5-8 The distance between PCS and container wall

5.5.2 Fan installed inside the container

When the fan is installed inside the container, its on the inner side of container door near the ventilation thermal outlet of the PCS.

The Dimension of the Fan and installation position below is just an examples. Please contact manufacture to confirm the Fan position for certain project.

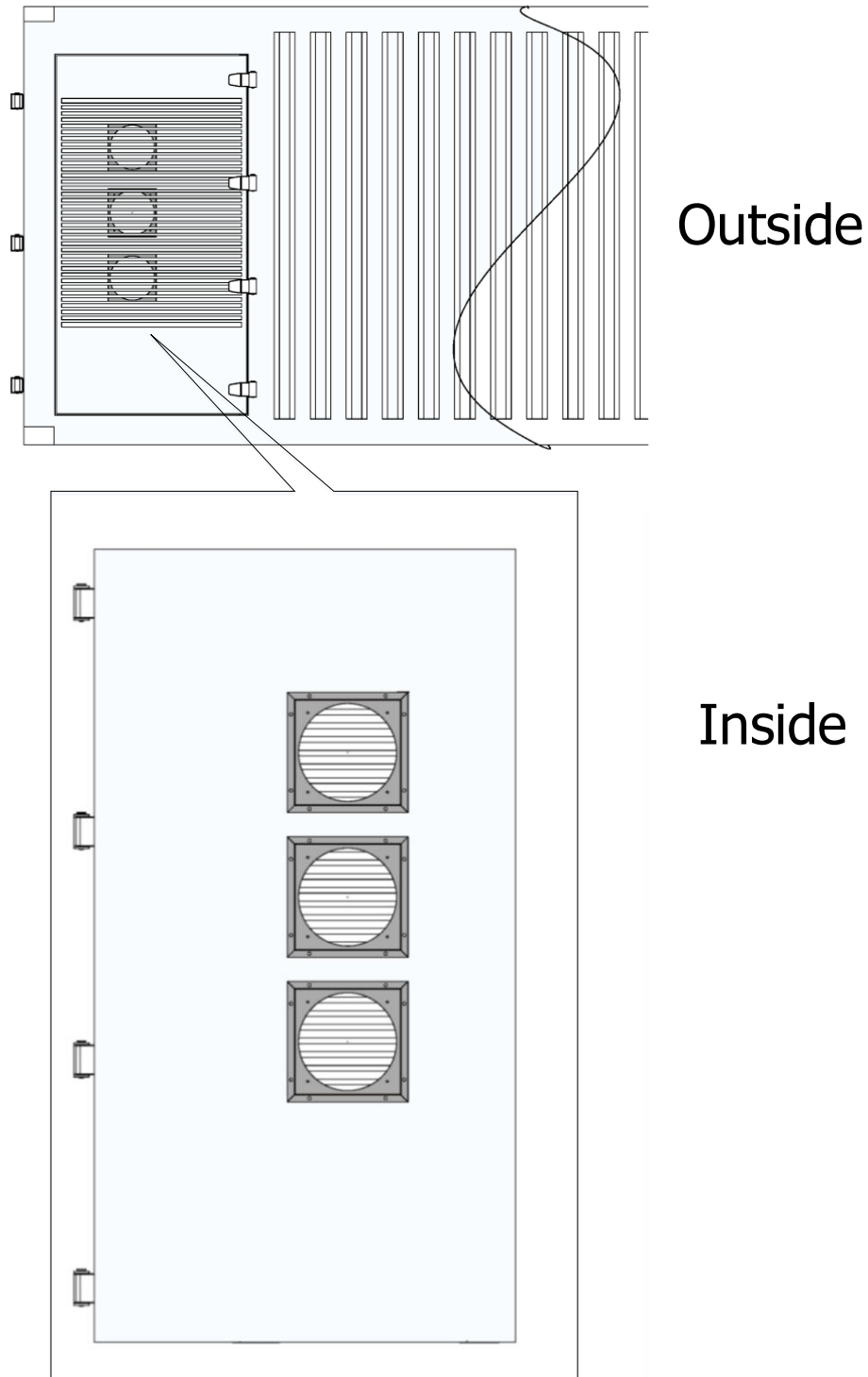

Fig. 5-9 The Fan on the inner side of container wall

5.5.3 Fan installed outside the container

The standard external fan module is recommended and easy to install.

When the fan is installed outside the container, its on the outward side of container door near the ventilation thermal outlet of the PCS.

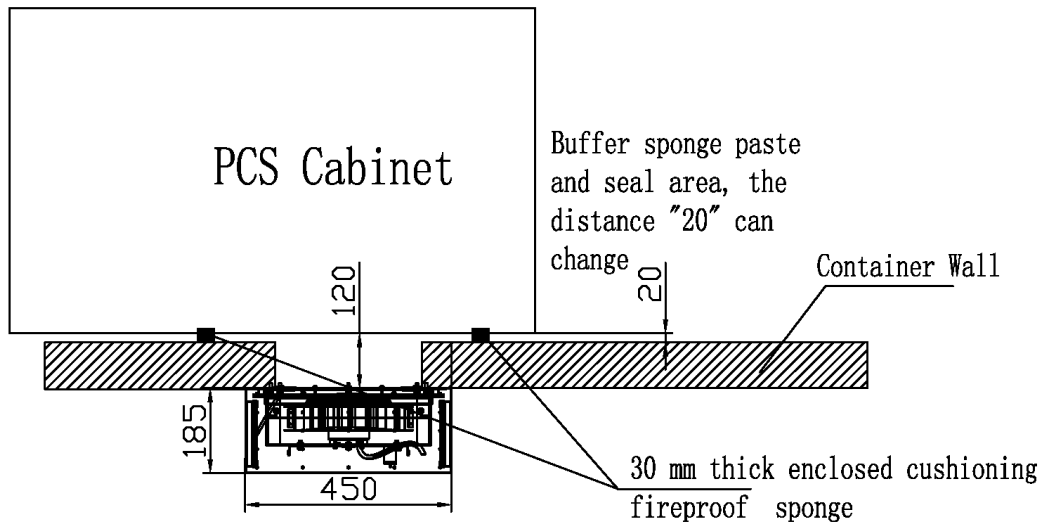

Fig. 5-10 Container external fan drawing

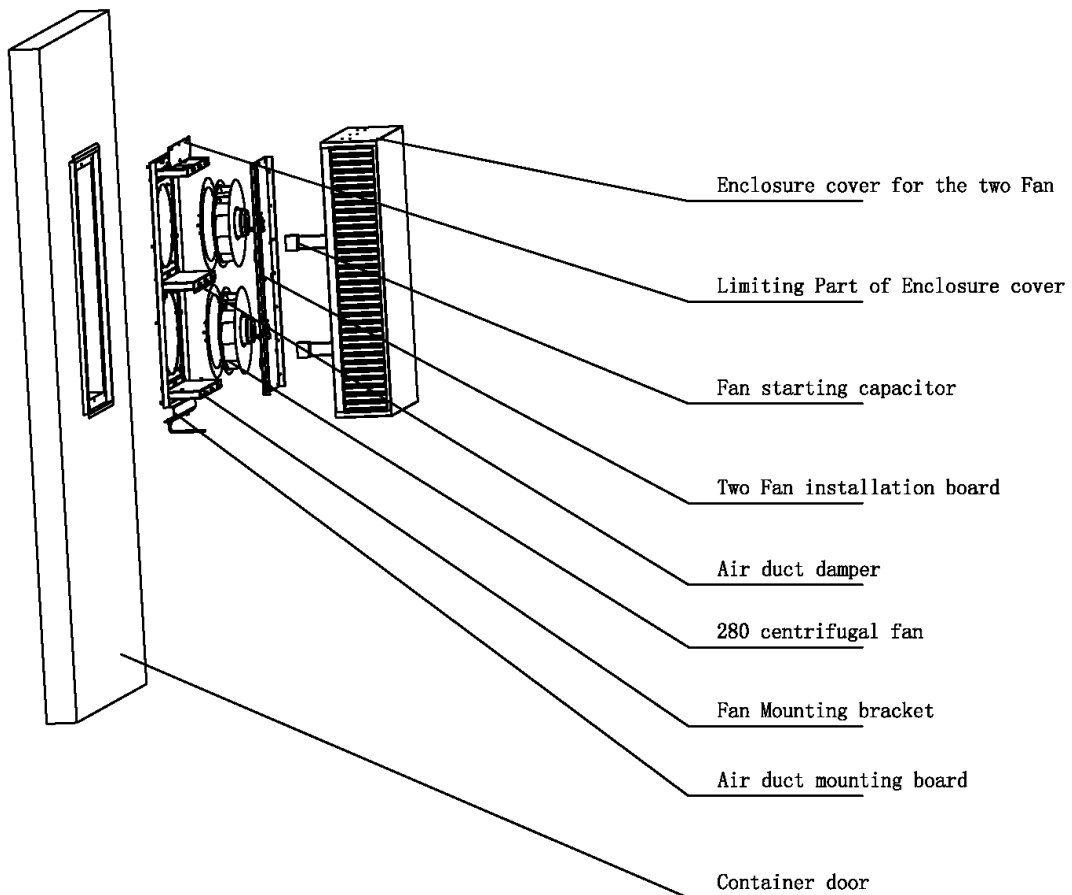

Fig. 5-11 Components of Container external fan

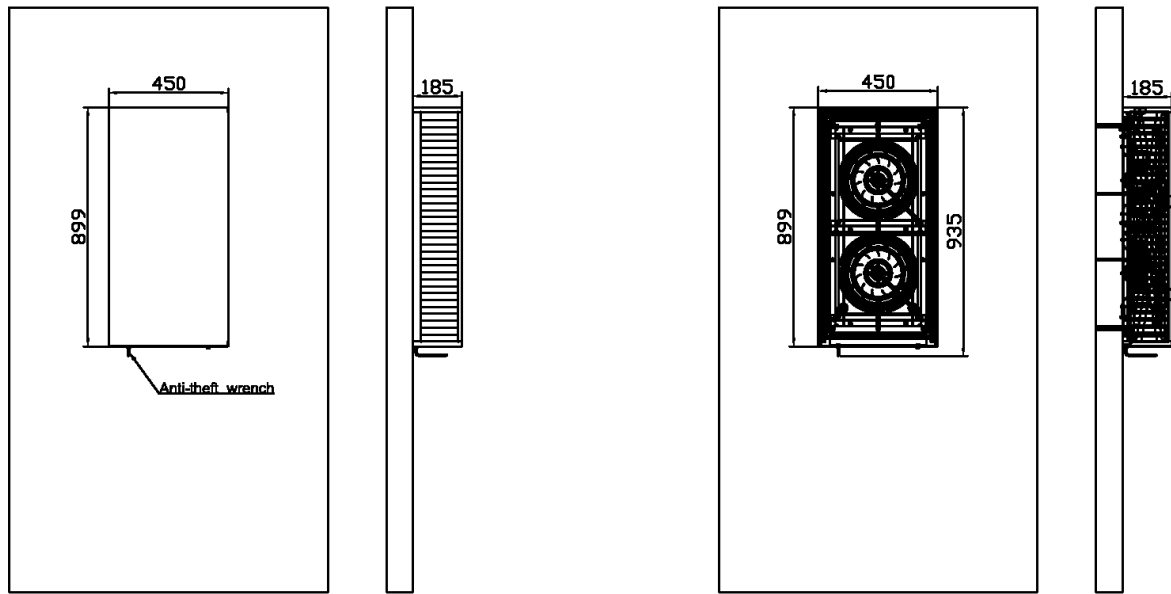

Fig. 5-12 Three external fan on the outward side of the door

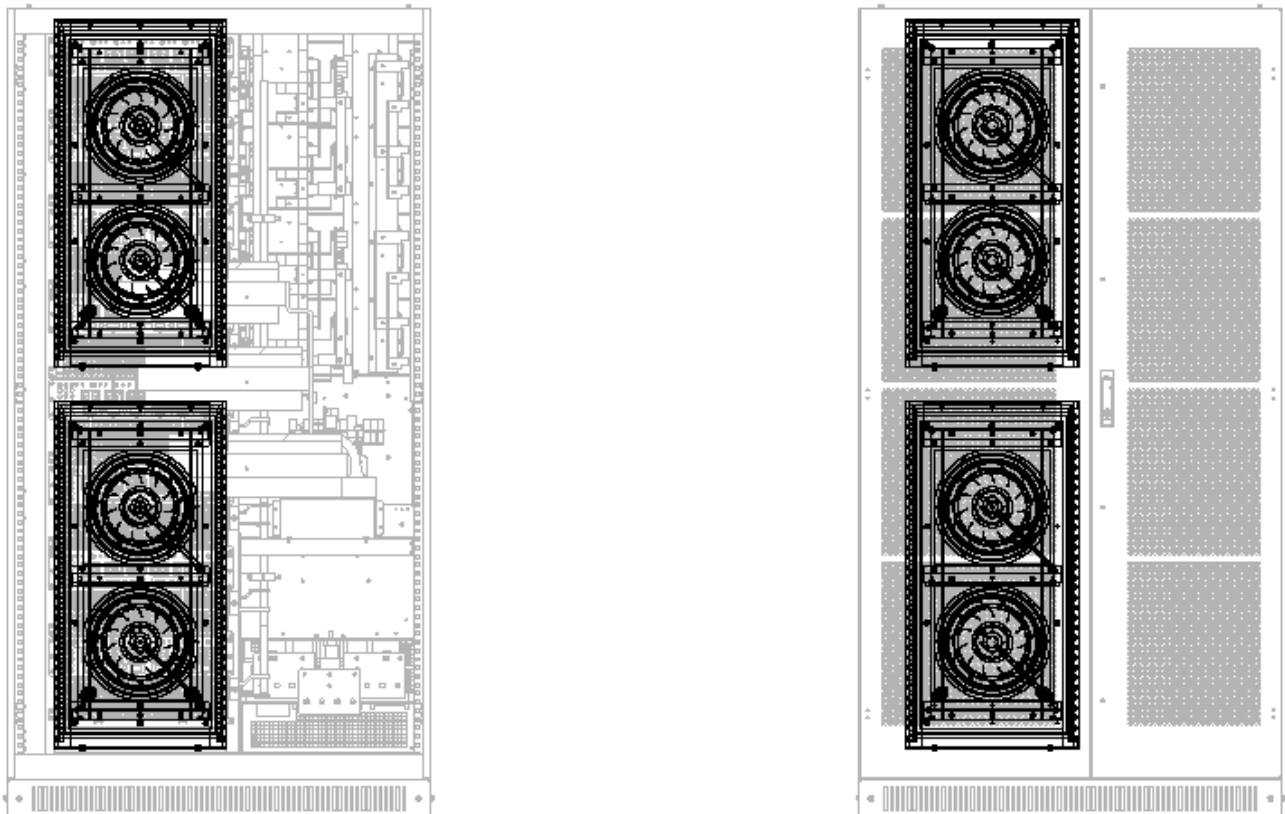

Fig. 5-13 PWS1-500K series Fan and its corresponding Module; Relative position of Fan and back door

5.5.4 Air duct design

Air duct can be customized design according to customer's requirements. Please contact the manufacture to

know the air duct design for specific project.

Model	System air demand	Ventilation air volume	Fan	Module	Inlet air area	Outlet air area
PWS1-500K series	5000 M ³ H	6400 M ³ H	4	2	0.6 m ²	0.8 m ²

This ventilation volume requirement is also applicable to the indoor installation.

5.5.5 Installation of Fan module

Fan module (including fans and fan covers) need to be disassembled when the container commissioning and transportation. The steps for disassembling and waterproofing the corresponding fan and hood are as follows:

Step 1. Fasten the fan assembly with the screw to the container.

Step 2. Lock the hood fixture with screws, do not tighten, so that it can be adjusted later.

Step 3. After connecting the cable, hang up the fan cover, adjust the fan cover fixing bracket of the step 2 to the appropriate position and fasten it.

Then fasten the fan cover with the anti-theft screw with flat elastic pad,

Then fix the Four-sided t joint the fan cover and the container body with waterproof glue.

Then the installation is finished.

The removal steps can be reversed from step 3 to step 1.

6 Electrical Installation

6.1 Electrical Connections

6.1.1 Input requirement

DC voltage of the PCS should be within the input voltage range, or the PCS will be unable to operate. When configuring the quantity of batteries in each string, the maximum charging voltage and minimum discharging voltage should be fully considered. For details, please consult our technical person.

The battery system working with the PCS should be equipped with DC switch and is recommended to be certified by CSA E61233 or UL1973. And the charging/discharging voltage should be between the input voltage range. It should also be equipped with DC air switch and the BMS certified by CSA No. 0.8 or UL991+UL1998. While connecting with external battery pack, please make sure DC and AC switches are disconnected.



NOTICE

For the multi-string models. Every DC input circuit branch in PCS should be able to operate independently. For multi-string models (e.g. PWS1-500KTL-XX), each DC input is independent from the other and should be connected with individual battery system. The batteries need to be connected to each branch port.

6.1.2 Output requirement

The output of the PCS is 3-phase . When designing energy storage system, the PCS of 500KTL series is without isolation transformer, its AC output side can directly be connected to the 3Wire without Neutral line low-voltage utility grid.

6.1.3 Wiring mode

The wiring mode of the PCS is down inlet and down outlet, the incoming and outlet wiring holes located in bottom of the PCS cabinet. The cables put into the cable trough via the wire holes at the base. Open the front door and dismantle the dam-board to seen wiring of the cooper bars. As for wiring requirements, single cables or multiple cables with proper wire diameter should be selected. It is suggested that the current in 1mm² wire should be $\leq 3A$.

The wiring methods should be in accordance with the National Electrical Code or other local standards, ANSI/NFPA 70 are to be used for NA version.

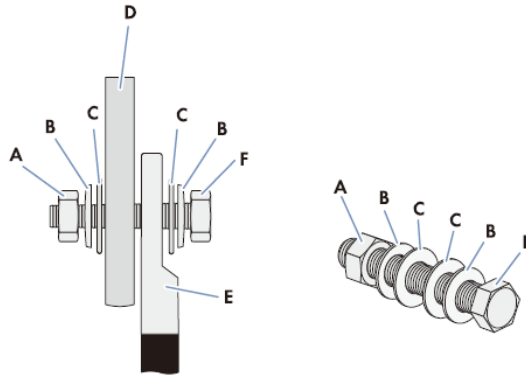

Fig. 6-1 Design of the connection with one one-hole terminal lug

Position	
A	Nut M10 and M12
B	Spring washer
C	Fender washer
D	Connection BUS bar
E	Tin-plated one-hole terminal lug
F	Screw M10 and M12

Open the dam-board of back door and then can see the wiring copper bar as shown below.

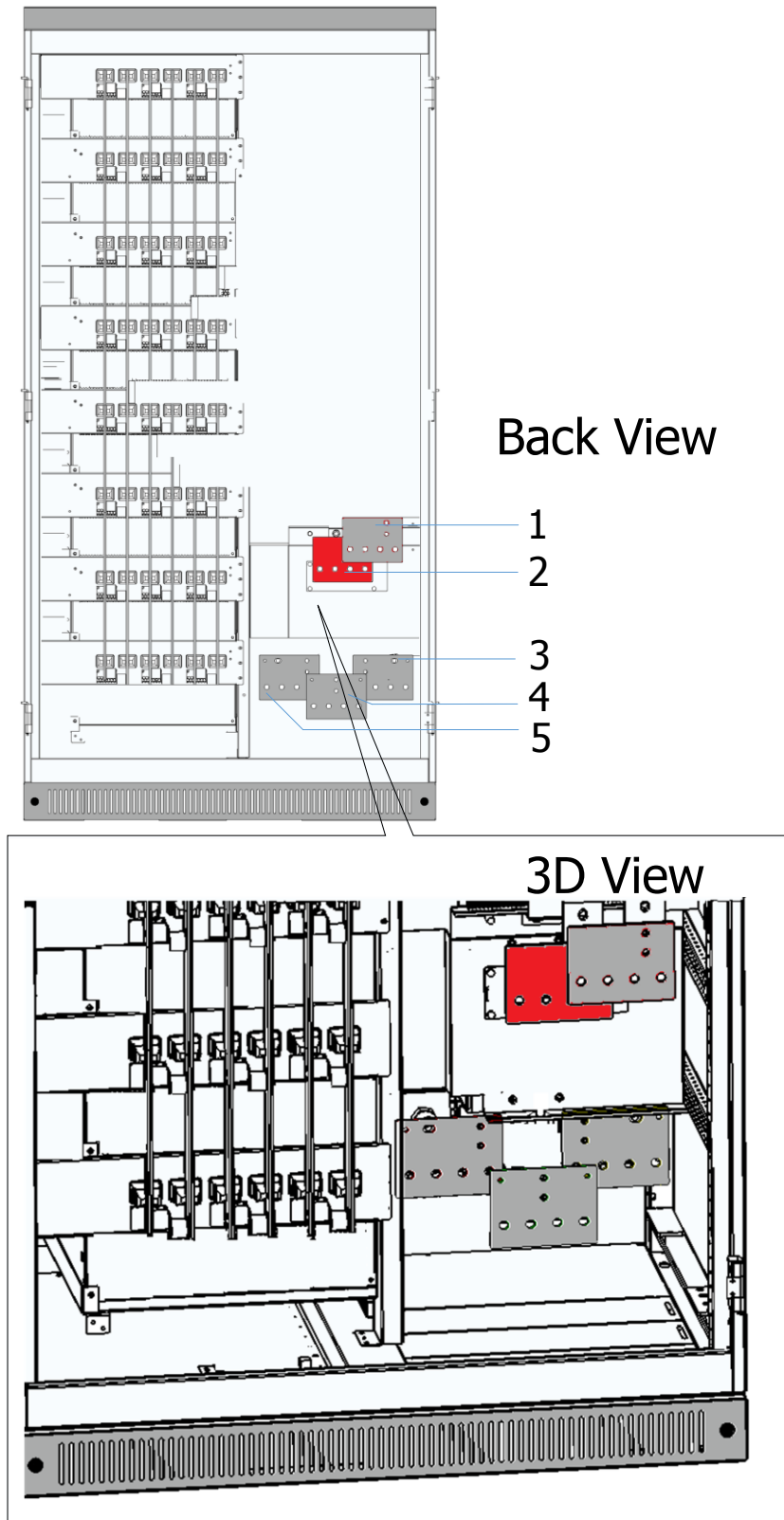

Fig. 6-3 PWS1-500K series with 1 branch DC input cabinet wiring copper bars designation

Table 6-3 PWS1-500K series with 1 branch DC input cabinet wiring copper bars description

Position	Designation	Description
1	Battery +	Battery input positive pole
2	Battery -	Battery input negative pole
3	A	Phase A, dimension is shown as below.
4	B	Phase B
5	C	Phase C

Fig. 6-4 PWS1-500K series with 1 branch DC input DC wiring copper bar dimension

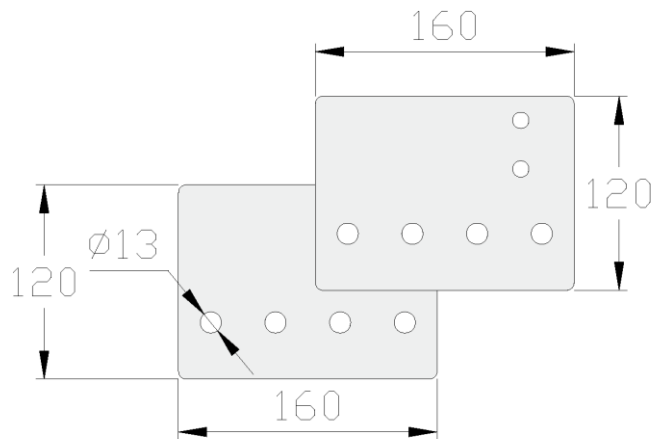
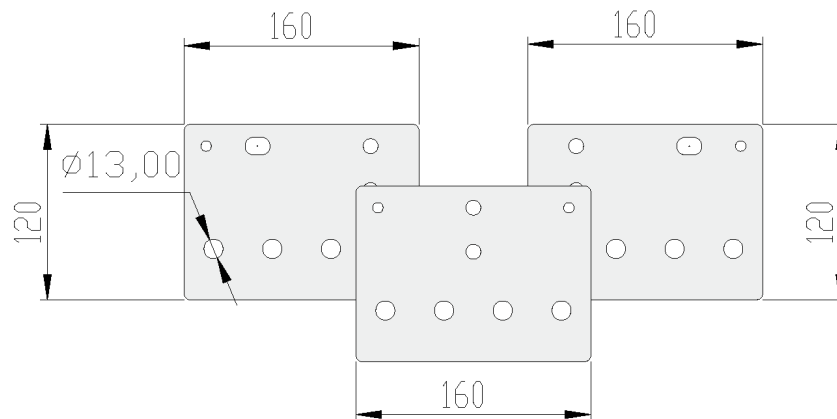

Fig. 6-5 PWS1-500K series AC wiring copper bars dimension



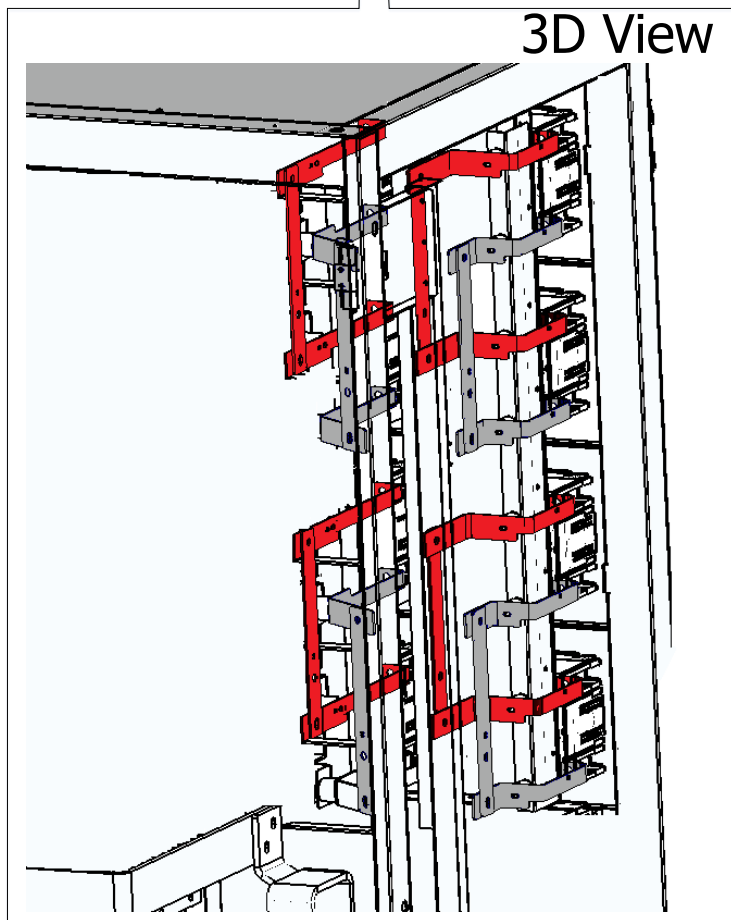
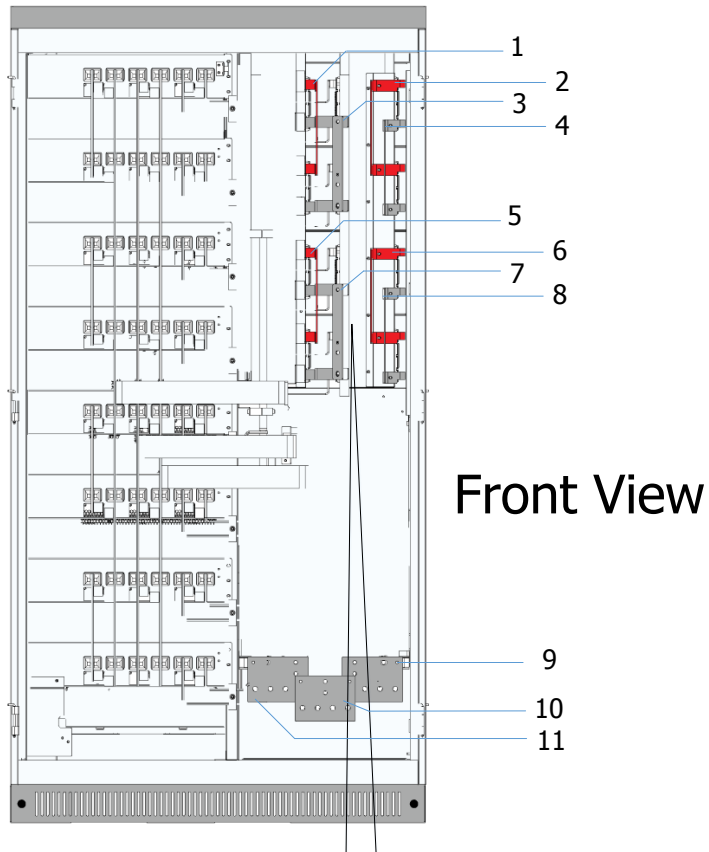

Fig. 6-6 PWS1-500K series with 4 branch DC input cabinet wiring copper bars designation

Table 6-4 PWS1-500K series with 4 branch DC input cabinet wiring copper bars description

Position	Designation	Description
1	Battery +	Battery positive port
2	Battery +	Battery positive port
3	Battery -	Battery negative port
4	Battery -	Battery negative port
5	Battery +	Battery positive port
6	Battery +	Battery positive port
7	Battery -	Battery negative port
8	Battery -	Battery negative port
9	A (Grid)	Phase A
10	B (Grid)	Phase B
11	C (Grid)	Phase C

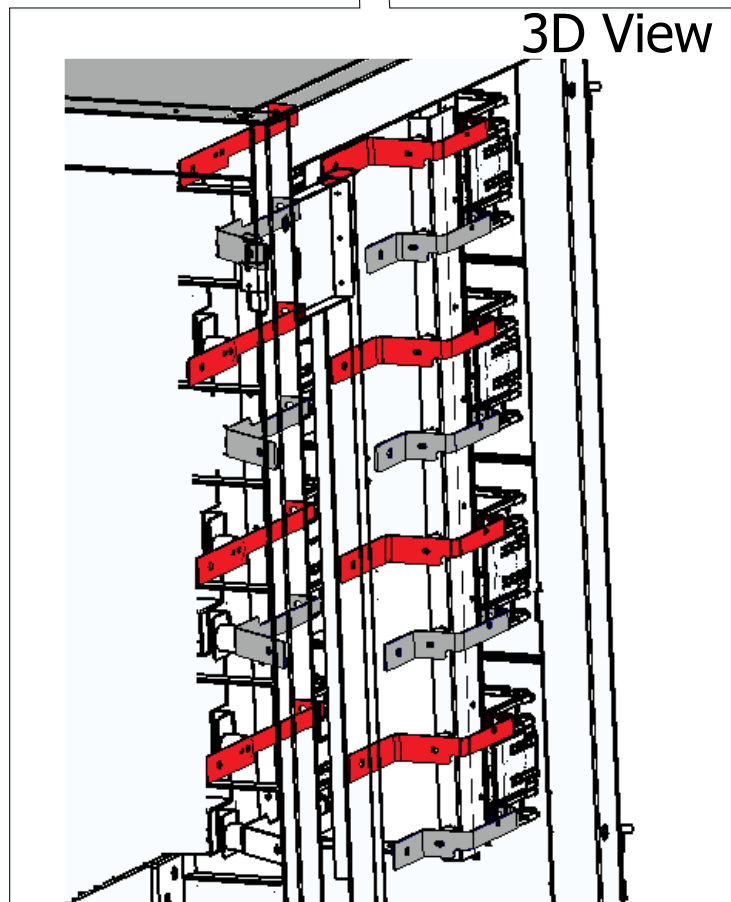
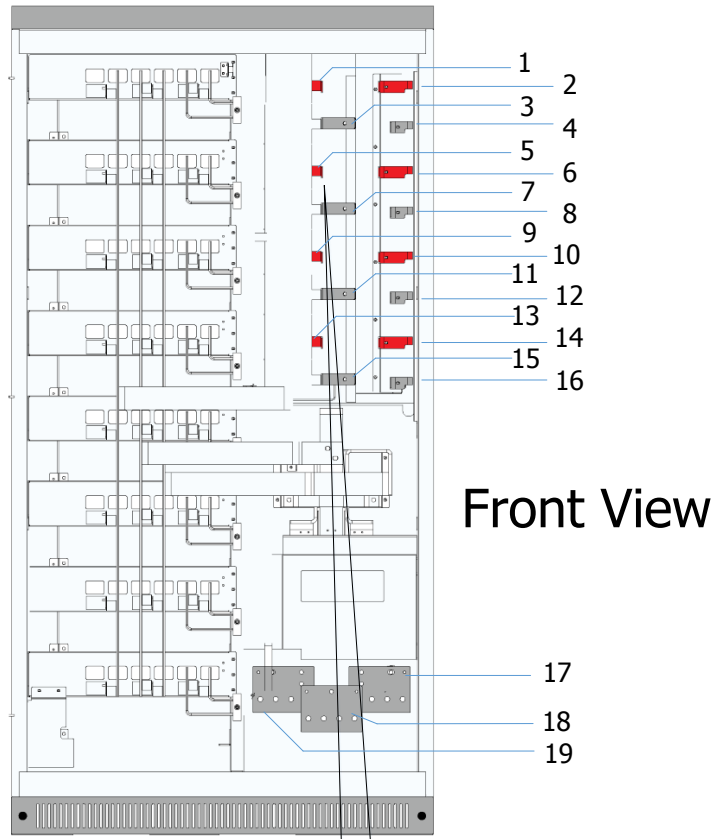

Fig. 6-7 PWS1-500K series with 8 branch DC input cabinet wiring copper bars designation

Table 6-5 PWS1-500K series with 8 branch DC input cabinet wiring copper bars description

Position	Designation	Description
1	Battery +	Battery positive port
2	Battery +	Battery positive port
3	Battery -	Battery negative port
4	Battery -	Battery negative port
5	Battery +	Battery positive port
6	Battery +	Battery positive port
7	Battery -	Battery negative port
8	Battery -	Battery negative port
9	Battery +	Battery positive port
10	Battery +	Battery positive port
11	Battery -	Battery negative port
12	Battery -	Battery negative port
13	Battery +	Battery positive port
14	Battery +	Battery positive port
15	Battery -	Battery negative port
16	Battery -	Battery negative port
17	A (Grid)	Phase A
18	B (Grid)	Phase B
19	C (Grid)	Phase C

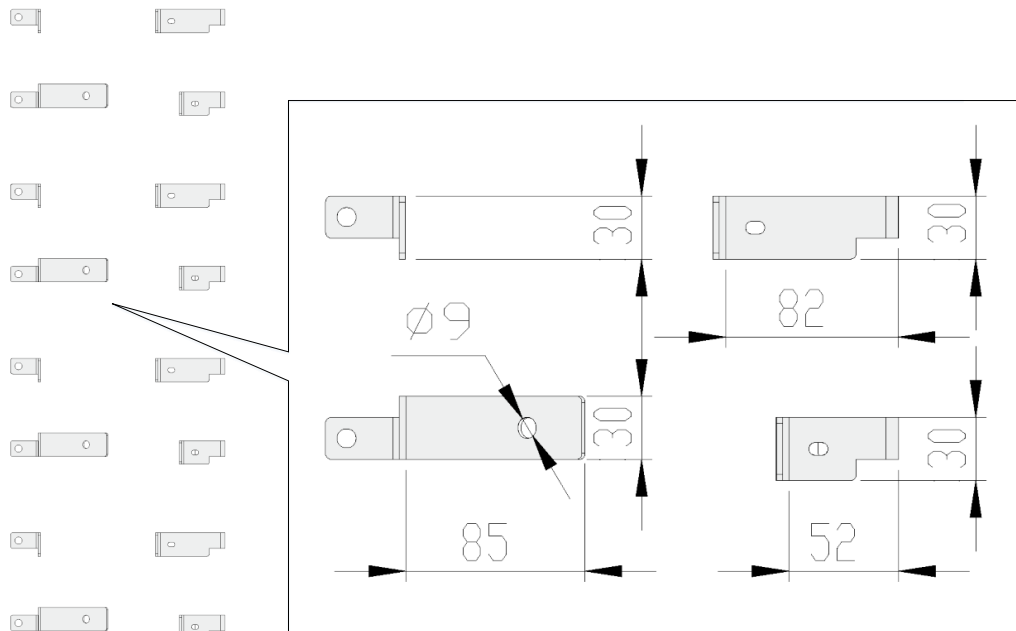

Fig. 6-8 PWS1-500K series with 8 branch DC input DC wiring copper bar dimension

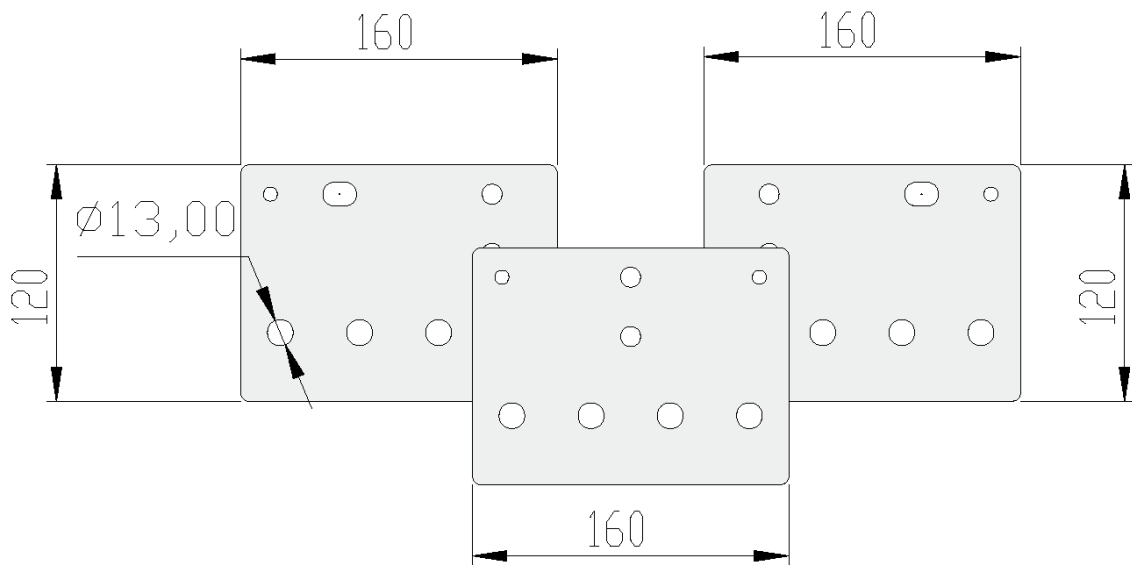

Fig. 6-9 PWS1-500K series AC wiring copper bars dimension

6.1.4 System grounding

The modules in the PCS realize grounding connection with the rack through hangers.

As for rack grounding, the rack bottom is installed with grounded copper bars. During wiring, refer to the following table for cable diameter. The grounding resistance should be less than 4Ω.



WARNING

Notice that the AC output neutral is not bonded to ground.

Table 6-5 Grounding PE cable description

Rated power	Copper PE line section recommendation (mm ²)
500kW	≥75



WARNING

Rack and modules need to be grounded reliably! The grounding resistance should be less than 4Ω.

6.1.5 DC port wiring

- 1) Use a multi-meter to measure the voltage of storage battery port, and ensure that the voltage is within input voltage range of PCS.
- 2) Disconnect DC switch. Wiring operation can be conducted after using a multi-meter to measure and confirm that there is no voltage between positive and negative poles of DC input.
- 3) Connect the positive pole of storage battery to "DC+" of DC input of DC switch.
- 4) Connect the negative pole of storage battery to "DC-" of DC input of DC switch.

5) Confirm wiring firmness.

Rated power	Copper DC line section recommendation (mm ²)
500kW	≥35 mm ² Each single core cable Three 95mm ² (Single Core) or four 70mm ² (Single Core) or thicker cable cross-sectional area.



DANGER

Disconnect DC distribution switch and ensure that there is no dangerous voltage in the system during wiring.



NOTICE

The positive and negative poles of batteries cannot be connected inversely. Before wiring, a multi-meter needs to be used for measurement.

6.1.6 AC port wiring

- 1) Use a phase-sequence meter for measurement, and ensure that the phase consequence of wires should be a positive consequence.
- 2) Disconnect AC output distribution switch in PCS.
- 3) Use a multi-meter to measure and ensure that the cables connected to the terminals are electrically neutral.
- 4) While grid-tied, A(L1)/B(L2)/C(L3) phases of AC output distribution switch of utility grid and PE are respectively connected to A(L1)/B(L2)/C(L3) phases of utility grid and PE.
- 5) If on-grid/off-grid switching function is to be achieved, extra power distribution unit and wires need to be added.
- 6) Confirm wiring firmness.

Rated power	Copper AC line section recommendation (mm ²)
500kW	≥70 mm ² Each single core cable, Three 3*150mm ² (three core) or four 3*95mm ² (three core) or thicker cable cross-sectional area.



WARNING

Ensure that there is no dangerous voltage at connection points during wiring.



NOTICE

All wires are connected to the wiring terminals externally from the wiring holes at the bottom of PCS. After wiring, fireproofing mud should be used to seal the wiring holes.

6.1.7 Wiring of terminal strips

Except power cable connection in the whole PCS, there are also auxiliary power connection, input and output of some node signals. All of them are led to the terminal strips with cluster cables in the rack. The port definition of external wiring for terminal strips is shown in figure below.

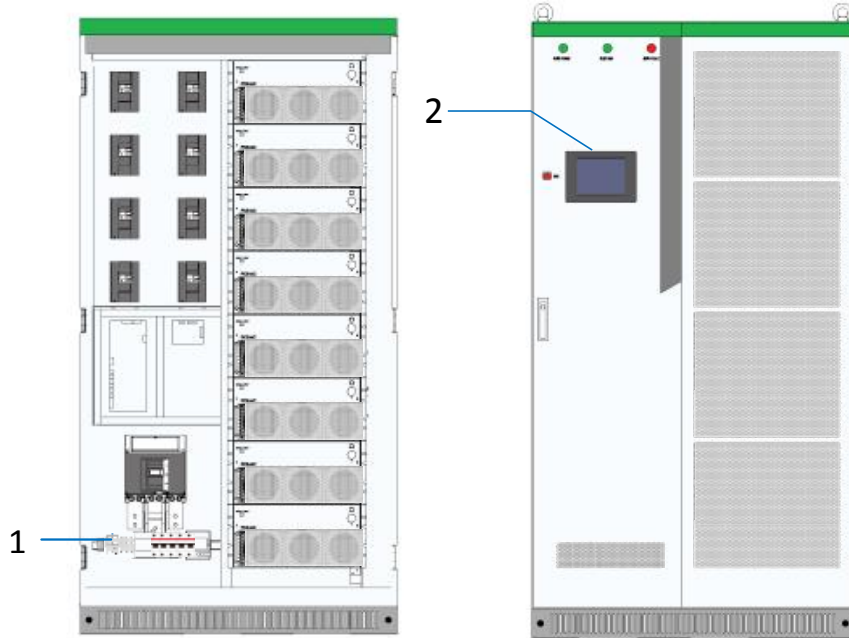

Fig. 6-8 Wiring and communication interface position

Table 6-6 Communication interface description

Interface position	Description	Explanation
1	Terminal strip ports	RS485 , CAN, DI, DO, AUX power Shown as 6.3.7 Wiring of terminal strips
2	Touch Screen	Ethernet port Shown as 6.4 Communication interface

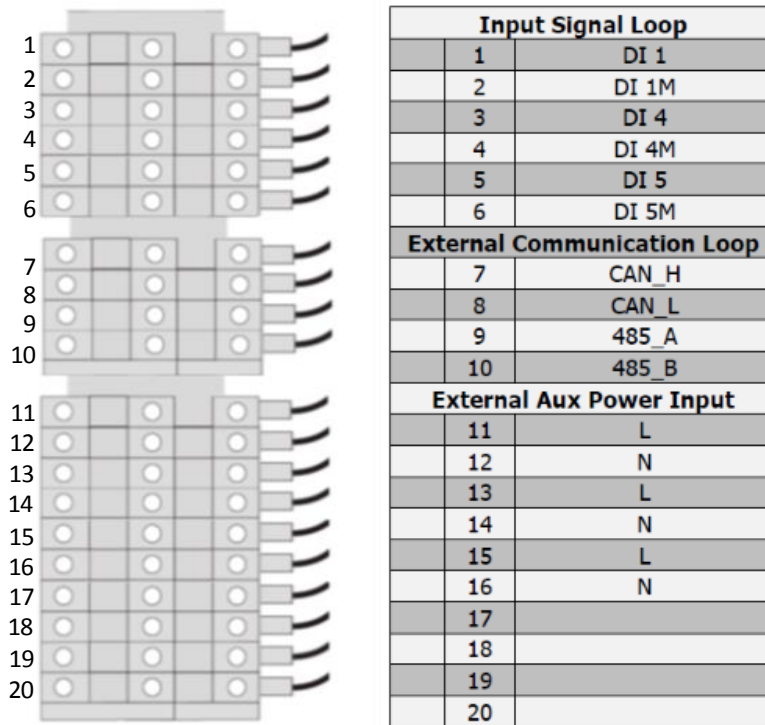

Fig. 6-9 Definition of terminal strip ports

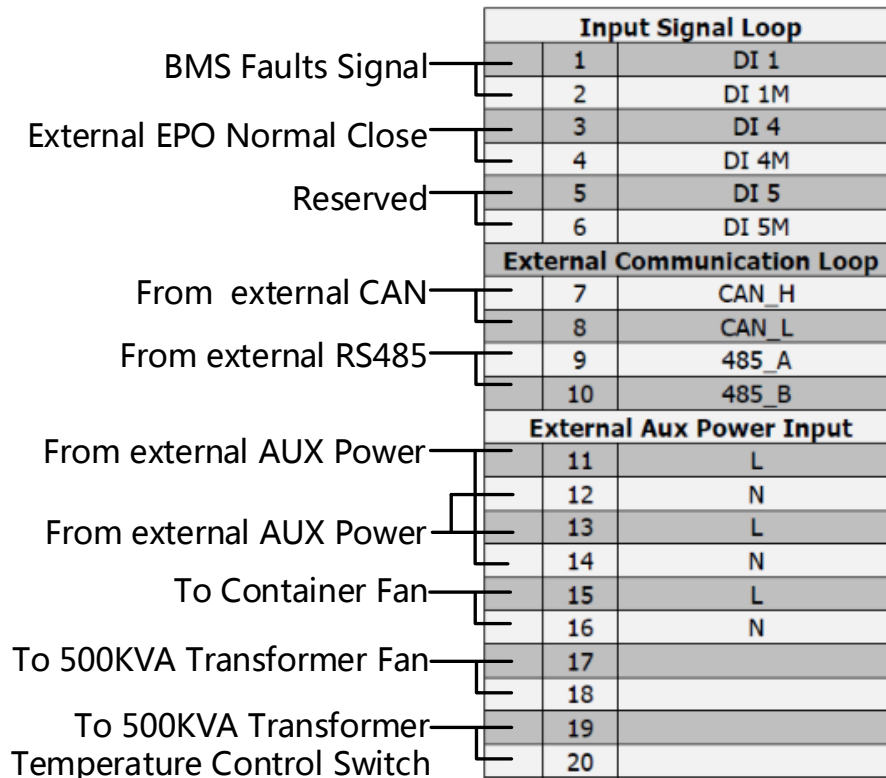

Fig. 6-10 Definition of terminal strip ports

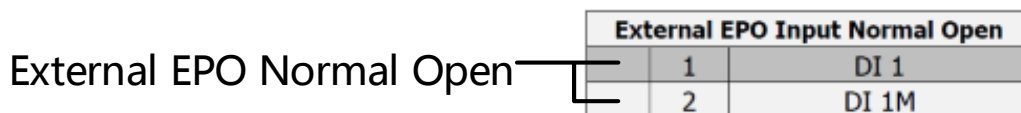

Fig. 6-11 Definition of additional terminal strip ports for 1 branch DC Input Switch

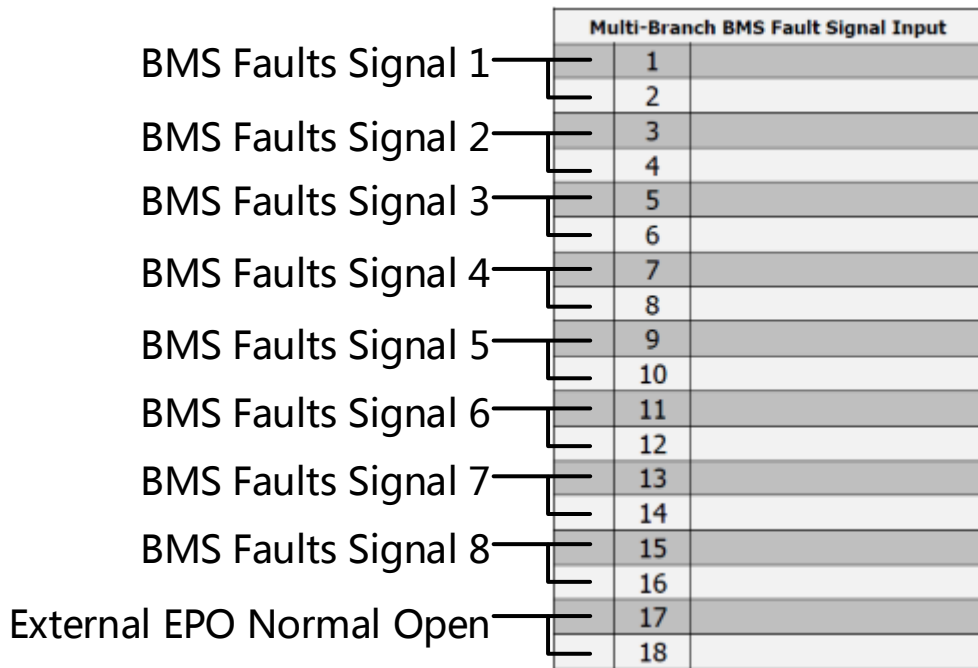

Fig. 6-12 Definition of additional terminal strip ports for 8 branch DC Input Switch

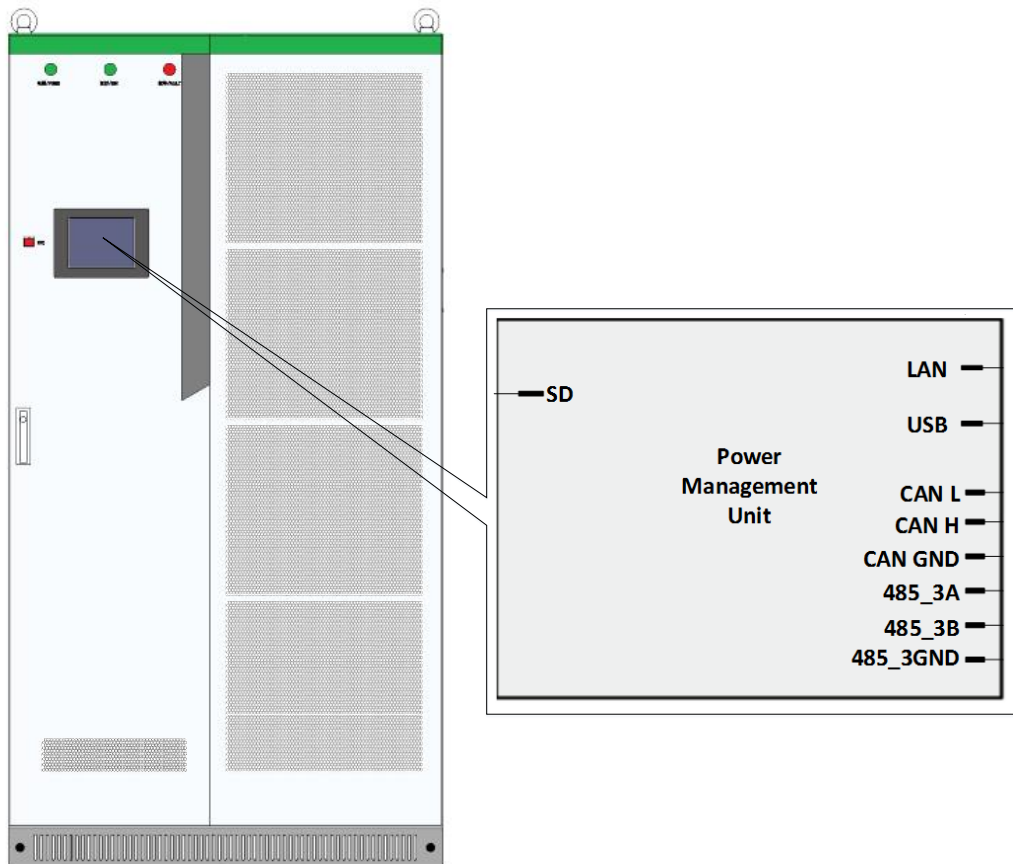

Fig. 6-13 Definition of touch screen communication ports

The LAN (Ethernet) port is used for communication. The USB port is used for system update or the logs export. The other communication ports in the back of touch screen has been wired to the wiring terminal

strip ports.

6.2 Communication interface

The PCS supports Modbus protocol, adopts RS485 and Ethernet communication interface and facilitates users to conduct background monitoring for the PCS and realizes remote signaling, remote metering, remote control and remote regulating of storage inverter.

Equipment	Wiring Method
EMS	RS485 or Ethernet (Protocol is based on MODBUS TCP/IP or MODBUS RTU compatible with SUNSPEC/MESA) Defaulted as RS485 MODEBUS RTU. Use Ethernet when the system require fast control. When the EMS need to communicate in CAN method, a CAN to Ethernet communication protocol converter is required.
BMS	RS485 or Ethernet or CAN (Protocol is based on MODBUS TCP/IP or MODBUS RTU compatible with SUNSPEC/MESA) Defaulted as CAN When the BMS need to communicate in Ethernet method, an Ethernet to CAN communication protocol converter is required.
Another PCS	CAN
Smart meter	Through external EMS
Air Conditioning	Through external EMS
Fire control	Through external EMS
Water Level Gauge	Through external EMS
Diesel Generators	Through external EMS

Table 6-7 Communication interface with other equipment

6.2.1 Connecting the EMS over RS485 or Ethernet

Sinexcel's PCS has several different communication interfaces: Ethernet, RS-485 and CAN.

When connecting to the Sinexcel or other brand EMS, the communication port is default as RS 485 as shown below.

The Ethernet communication port can also used to connecting EMS according to the requirements for certain project.

RS 485 Port

The front door of the storage inverter is embedded with touch screen Management Unit. User interface can be seen at its back. The position of RS485 communication interface in the back of HMI (Touch Screen). It is led to terminal strip ports 9 and 10. Users can transfer serial port signal to the one which can be processed by PC via interface converter (such as RS485 transferred to RS232). The storage inverter could be set and commissioned alone via background software. It can read operation and warning information. Corresponding settings, startup and shut down operations can be conducted.

Ethernet Port

The monitoring panel integrates Ethernet port with position numbered as RJ25 that can be seen in the back of the touch screen. It supports Modbus TCP/IP protocol and has its own IP address. Ethernet connection requires a switch router, and fixed IP needs to be set. Connecting cables are twisted pair (namely network cable). The internet ports of multiple the storage inverter are connected to the switch router, and the switch router is connected to remote control computer. The state of the storage inverter can be monitored and controlled in real time after setting IP address and port number in the monitoring computer.

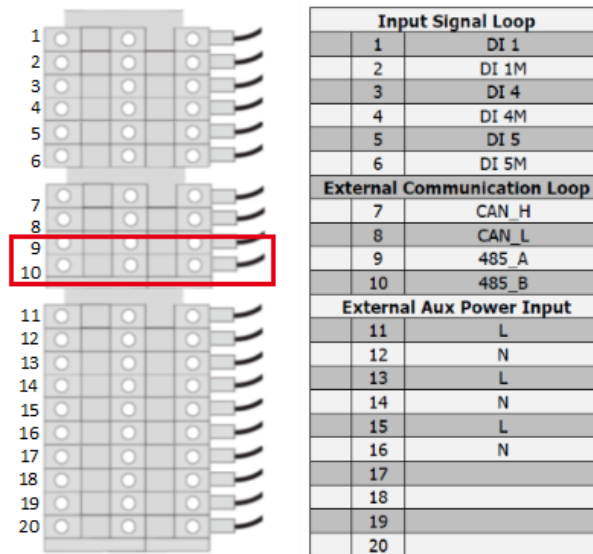

Fig. 6-14 PCS RS485 communication terminal

6.2.2 Connecting a BMS over CAN

When directly connecting to the BMS, the communication port is default as CAN as shown below. If the BMS use Ethernet communication port, a Ethernet-CAN protocol converter is needed . That Ethernet-CAN protocol converter should be bought by the user and its beyond Sinexcel’s scope of supply. The PCS communicates with battery management unit (BMS) to monitor battery state information, give an alarm and provide fault protection for battery according to the battery state and improve the safety of storage battery. It supports CAN communication. In particular, the position number of CAN communication interface can be seen in the back of HMI (Touch screen). It is led to terminal strip ports 7 and 8.

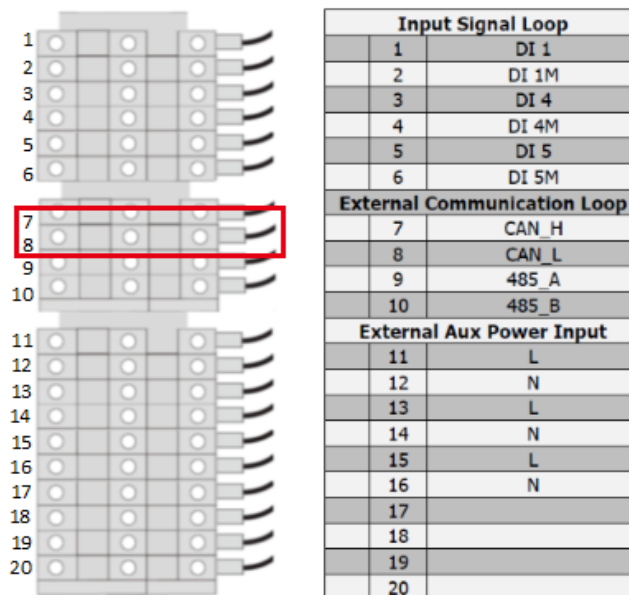

Fig. 6-15 PCS CAN communication terminal

6.3 Check after installation

After installation of PCS, inspection is conducted after the installation:

- 1) The device should be placed and should be installed reasonably, meeting safe distance requirements.
- 2) Wiring should be correct. Lower leading wire and ground screen are in good connection. The constructor

is required to inspect the grounding resistance.

3) Compare ex-factory main wiring diagram provided by the manufacture and site wiring. Check whether there is any difference and judge whether such difference will affect the safe operation of energy storage system.

7 Installation checklist

After finishing the installation, check the list below:

Mechanical installation	√
There is sufficient free space in front and at the back of the unit.	<input type="checkbox"/>
The module fastening bolts is removed	<input type="checkbox"/>
The ambient operating conditions are within the range in specification.	<input type="checkbox"/>
The unit is properly fastened to the floor.	<input type="checkbox"/>
Nothing blocked the air ventilation of the PCS and the air tunnel is through.	<input type="checkbox"/>
Electrical installation	√
The PCS (including cables) is grounded properly and the earthing electrodes are constructed properly.	<input type="checkbox"/>
The AC line voltage matches the nominal output voltage of the PCS	<input type="checkbox"/>
The external MV or LV AC transformer is suitable for use with the PCS	<input type="checkbox"/>
The insulation of the assembly is good and meet the code	<input type="checkbox"/>
The AC power connections at A, B and C and their tightening torques are correct.	<input type="checkbox"/>
The DC power cable connections at DC+ and DC- and their tightening torques are correct.	<input type="checkbox"/>
The AC and DC power cable wiring holes are sealed properly.	<input type="checkbox"/>
The auxiliary and control cables are routed away from the power cables	<input type="checkbox"/>
The external control connections to the PCS are correct	<input type="checkbox"/>
The cable connections at the junction box and their tightening torques are correct.	<input type="checkbox"/>
There are no tools, foreign objects or dust inside the cabinet.	<input type="checkbox"/>
All of the dam-boards and covers are in place. Especially the dam-board below the front door is installed.	<input type="checkbox"/>
All of the doors and door locks are in place.	<input type="checkbox"/>
Insulation withstand test	<input type="checkbox"/>
The grounding resistance should be less than 4Ω.	<input type="checkbox"/>

8 Start-up and Operation

Please refer to the Operation Manual for details.

Possible chapter and contents.

Chapter 7 Function Description

Chapter 8 Operation

Chapter 9 Troubleshooting

9 Contact

If you have technical problems with our products, please contact the service hotline. Please provide the following information to help you with the necessary assistance:

- Equipment model
- Serial number
- Battery type and number
- Communication type
- Firmware version
- Error number and error message

Shenzhen Sinexcel Electric Co., Ltd.

Website: <http://sinexcel.us/> or www.sinexcel.com

Add: Building 6, Area 2, Baiwangxin High-tech Industrial Park, No. 1002, Songbai Road, Nanshan District, Shenzhen

Postcode: 518055

Hotline: +86 0755-8651-1588